



UPVFD04-D230AC

Open Chassis Microprocessor-based
Variable Frequency AC Drive

Specifications

Model	Line Voltage (VAC)	Motor Voltage (VAC)	Continuous Motor Current (Amps)	Motor Horsepower Range
UPVFD04-D230AC	115	115		1/8 - 1/2
	230	230	4.0	1/4 - 1

AC Line Voltage.....115/230 VAC \pm 10%, 50/60 Hz, single phase
AC Line Current with 115 VAC line voltage with a 115V motor..... approx. 2x motor current
with 115 VAC line voltage with a 230V motor..... approx. 4x motor current
with 230 VAC line voltage with a 230V motor.....approx. 2x motor current
AC Motor Voltage.....115/230 VAC, 50/60 Hz, single or three phase
Overload Capability.....200% (2x) for 1 minute
Standard Carrier Frequency.....16 kHz
Output Frequency Range.....0 - 120 Hz
Adjustable Maximum Output Frequency Range.....30 - 120 Hz
Adjustable Minimum Output Frequency Range.....0 - 50% of maximum
Adjustable DC Injection Voltage.....0 - 35 VDC
Acceleration Time Range.....1 - 12 seconds
Deceleration Time Range.....1 - 12 seconds
Analog Input Voltage Range (Signal must be isolated).....0 - 5 VDC
Input Impedance (S1 to S2).....>100K ohms
Vibration (0 - 50 Hz).....0.5G maximum
(>50 Hz).....0.1G maximum
Ambient Temperature Range.....0°C - 40°C
Weight.....1.4 lbs

Safety Warnings

READ ALL SAFETY WARNINGS BEFORE INSTALLING THIS EQUIPMENT

- DO NOT INSTALL, REMOVE, OR REWIRE THIS EQUIPMENT WITH POWER APPLIED.** Have a qualified electrical technician install, adjust and service this equipment. Follow the National Electrical Code and all other applicable electrical and safety codes, including the provisions of the Occupational Safety and Health Act (OSHA), when installed equipment.
- Circuit potentials are at 115 or 230 VAC above earth ground.** Avoid direct contact with the printed circuit board or with circuit elements to prevent the risk of serious injury or fatality. Use a non-metallic screwdriver for adjusting the calibration trim pots. Use approved personal protection equipment and insulated tools if working on this drive with power applied.
- Reduce the chance of an electrical fire, shock, or explosion by proper grounding, over-current protection, thermal protection, and enclosure. Follow sound maintenance procedures.
- Minarik Drives strongly recommends the installation of a master power switch in the line voltage input.** The switch contacts should be rated for 250 VAC and 200% of motor nameplate current.
- Removing AC line power is the only acceptable method for emergency stopping.** Do not use DC injection braking, decelerating to minimum speed, or coasting to a stop for emergency stopping. They may not stop a drive that is malfunctioning. Removing AC line power is the only acceptable method for emergency stopping.
- Line starting and stopping (applying and removing AC line voltage) is recommended for infrequent starting and stopping of a drive only. DC injection braking, decelerating to minimum speed, or coasting to a stop is recommended for frequent starts and stops. Frequent starting and stopping can produce high torque. This may cause damage to motors.
- Do not disconnect any of the motor leads from the drive unless power is removed or the drive is disabled. Opening any one lead while the drive is running may destroy the drive.
- Under no circumstances should power and logic level wires be bundled together.
- Be sure potentiometer tabs do no make contact with the potentiometer enclosure. Grounding the input will cause damage to the drive.
- Caution should be taken when operating fan-cooled motors at low speeds because their fans may not move sufficient air to properly cool the motor. Minarik Drives recommends "inverter-duty" motors when the speed range is beyond 10:1.
- Drive is designed to work with permanent split capacitor, shaded pole, and standard three phase induction motors. In general, the drive can work with capacitor-start motors, but it is conditional on the current pull when the capacitor is in effect and how long the application calls for a speed that the capacitor will stay in the auxiliary winding. It is recommended to contact the motor manufacturer to see if the motor can be ran with a VFD.

Dimensions

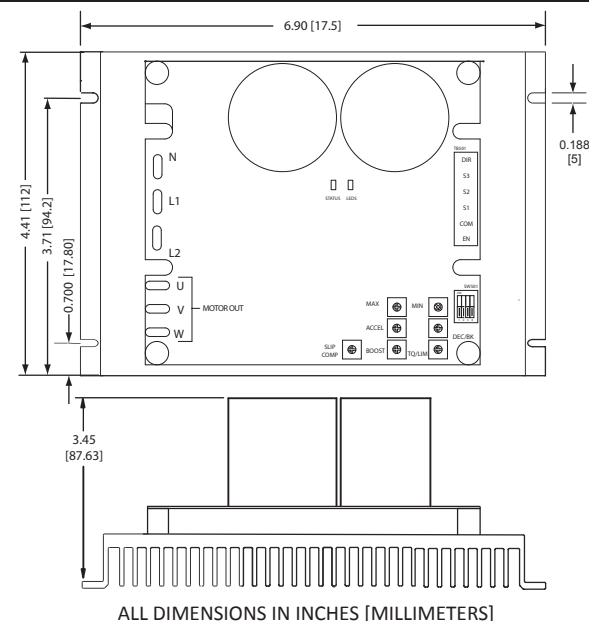

Installation

Mounting

- Drive components are sensitive to electrostatic discharge. Avoid direct contact with the circuit board. Hold the drive by the chassis only.
- Protect the drive from dirt, moisture, and accidental contact.
- Provide sufficient room for access to the terminal block and calibration trim pots.
- Mount the drive away from heat sources. Operate the drive within the specified ambient operating temperature range.
- Prevent loose connections by avoiding excessive vibration of the drive.
- Mount the drive with its board in either a horizontal or vertical plane. Four 0.20" (5 mm) wide slots in the chassis accept #8 pan head screws.
- The heat sink should be earth grounded. Use a star washer beneath the head of at least one of the mounting screws to penetrate the anodized heat sink surface and to reach bare metal.

Wiring

Use 18 - 24 AWG wire for logic wiring (COM, DIR, EN, S1, S2, S3).
 Use 14 - 16 AWG wire for AC line (L1, L2, N) and motor (U, V, W) wiring.

Shielding Guidelines

As a general rule, Minarik Drives recommends shielding of all conductors. If it is not practical to shield power conductors, Minarik Drives recommends shielding all logic-level leads. If shielding of logic-level leads is not practical, the user should twist all logic leads with themselves to minimize induced noise. Refer to the user's manual for details on earth grounding shielded wires and filtering.

Fusing

Minarik Drives drives require an external line fuse for protection. Use fast acting fuses rated for 250 VAC or higher and 150% of the maximum line current. Fuse the HOT leg of the AC line when using 115 VAC or both legs when using a 230 VAC line.

Line Input

Connect the AC line power leads to terminals L1 and N if using 115 VAC line power or to L1 and L2 if using 230 VAC line power. Minarik Drives recommends the use of a single-throw, double-pole master power switch. The switch should be rated at a minimum of 250 VAC and 200% of motor current.

Motor

If using a three phase motor, connect the AC motor leads to terminals U, V, and W. If the motor does not spin in the desired direction, power down the drive and swap any two of these connections. If using a single phase motor, connect the AC motor leads to terminals U and V. Refer to the Operations section for possible wiring setups.

Speed Potentiometer or Analog Input Signal LOGIC

Use a 5K - 20K ohm, 1/4 W potentiometer for speed control. Connect the counter-clockwise end of the potentiometer to S1, the wiper to S2, and the clockwise end to S3. If the potentiometer works inversely of desired functionality, (i.e. to increase motor speed, you must turn the potentiometer counterclockwise), power off the drive and swap the S1 and S3 connections. The drive may also follow a 0-5 VDC analog signal that is isolated from earth ground. Connect the signal common to terminal S1 and the signal input to terminal S2. To use a PWM signal, use adder card 200-0441.

Direction Switch

If a direction switch is desired, wire a switch to terminals COM and DIR. When the connection is open, the motor will run in the forward direction. When the connection is closed, the motor will run in reverse. If no direction switch is desired, leave this connection open.

Enable

Open the terminals COM and EN to coast the motor to minimum speed. Close terminals COM and EN to accelerate the motor to set speed. If no enable switch is desired, jumper terminals COM and EN. **Do not use the enable for emergency stopping.**

Connections

POWER

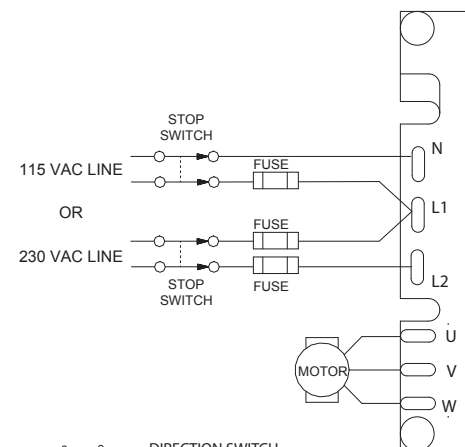

T8501

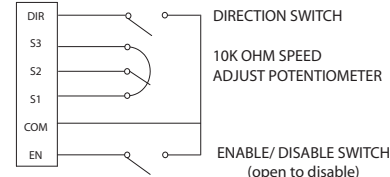

Startup

SELECT SWITCHES

Select Switch (SW501)

Switch 1: ON - 115 VAC out - Sets a 115 VAC output at base frequency determined by switch 3.

OFF - 230 VAC out - Sets a 230 VAC output at base frequency determined by switch 3.

Switch 2: ON - DC Injection Braking. The drive will use DC injection braking to quickly decelerate the motor.

OFF - Coast to Stop. The fastest the motor will decelerate is a natural coast to a stop.

Switch 3: ON - 50 Hz motor setting

OFF - 60 Hz motor setting

Switch 4: ON - 1.6 kHz Carrier Frequency

OFF - 16 kHz Carrier Frequency

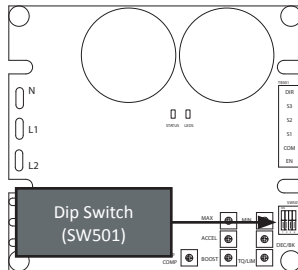

STARTUP

- Verify that no foreign conductive material is present on the printed circuit board.
- Ensure that all dip switches are properly set.

1. Turn the speed adjust potentiometer full counterclockwise (CCW).
2. Apply AC line voltage.
3. Enable the drive.
4. Slowly advance the speed adjust potentiometer clockwise (CW). The motor slowly accelerates as the potentiometer is turned CW. Continue until the desired speed is reached.
5. Remove AC line voltage from the drive to coast the motor to a stop.

LEDs

Power (IL2): Green LED lights whenever AC line voltage is applied to the drive.

Solid: Power is applied and the output is disabled.

Flashing: Power is applied and the output is enabled.

Status (IL1): Red LED lights whenever a fault condition occurs.

- Solid: Current Limit - The motor is asking for more current than drive is set to allow out.
- 2: Undervoltage - Internal DC BUS voltage dropped too low.
 - 3: Overvoltage - Internal DC BUS voltage rose too high.
 - 4: Short Circuit - Short circuit between any two phases on output.
 - 5: Overtemperature Warning - Drive's temperature is approaching critical temperature.
 - 6: Overtemperature Shut Down - Drive's temperature has reached critical temperature.
 - 7: Manual Start Trip - Power was applied while the enable was closed (only applicable if switch 1 on SW501 is set to ON).

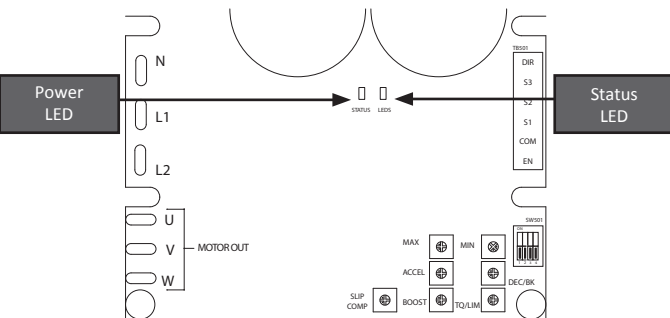

Copyright 2014 by Minarik Drives - All right reserved. No part of this document may be reproduced or retransmitted in any form without written permission from Minarik Drives. The information and technical data in this document are subject to change without notice. Minarik Drives makes no warranty of any kind with respect to this material, including, but not limited to, the implied warranties of its merchantability and fitness for a given purpose. Minarik Drives assumes no responsibility for any errors that may appear in this document and makes no commitment to update or to keep current the information in this document.

Operation

MOTOR CONNECTIONS

Single Phase Operation - Non-reversing

For single phase operation, connect the motor as show in the figure below. Ensure that the prewired capacitor and its associated motor coil are connected to terminals U and V as shown. This connection may be internal if using a 2-wire motor. If the motor has three leads, you must make this connection yourself.

This connection may be internal to the motor (2-wire). If not, you must make this connection yourself.

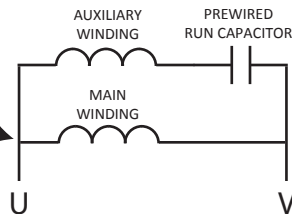

Single Phase Operation - Reversing

Remove the capacitor and connect the motor as show in the figure below. While allowing for solid-state reversing, this wiring scheme may result in sub-optimal motor operation. Depending on the motor construction and application requirements, the motor may need to be derated.

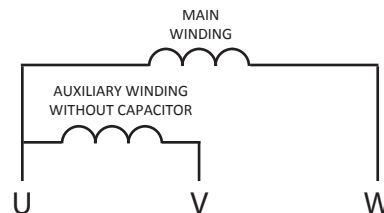

Three Phase Operation

For three phase operation, connect the motor as show in the figure below. Connect to terminals U, V, and W as shown.

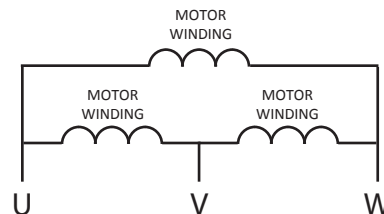

Calibration

Minimum Speed (MIN): The MIN setting determines the motor speed when the speed adjust potentiometer is set for minimum speed. It is factory set for zero speed. To calibrate the MIN:

1. Set the MIN trim pot full CCW.
2. Set the speed adjust potentiometer for minimum speed (full CCW).
3. Adjust MIN trim pot until the desired minimum speed is reached.

Maximum Speed (MAX SPD): The MAX setting determines the motor speed when the speed adjust potentiometer is set for maximum speed. To calibrate the MAX SPD:

1. Set the MAX SPD trim pot full CCW.
2. Set the speed adjust potentiometer for maximum speed (full CCW).
3. Adjust MAX SPD trim pot until the desired maximum speed is reached.

Slip Compensation (SLIP COMP): The SLIP COMP setting determines the degree to which motor speed is held constant as the motor load changes. It is factory set for optimum motor regulation. To calibrate the SLIP COMP:

1. Set the SLIP COMP trim pot full CCW.
2. Increase the speed adjust potentiometer until the motor runs at midspeed without load. A handheld tachometer may be used to measure motor speed.
3. Load the motor to its full load current rating. The motor should slow down.
4. While keeping the load on the motor, rotate the SLIP COMP trim pot until the motor runs at the speed measured in step 2. If the motor oscillates (overcompensation), the SLIP COMP trim pot may be set too high (CW). Turn the SLIP COMP trim pot CCW to stabilize the motor.
5. Unload the motor.

Boost (BOOST): The BOOST setting increases the motor torque at low speeds. The minimum setting is sufficient for most applications and does not need to be adjusted. If the motor stalls or runs erratically at very low speeds (below 10 Hz), the boost trim pot may need adjustment. To calibrate the BOOST:

1. Run the motor at the lowest continuous speed/frequency required.
2. Increase the BOOST trim pot until the motor runs smoothly. **Continuous operation beyond the motor's current rating may damage the motor.**

Acceleration (ACCEL): The ACCEL setting determines the time the motor takes to ramp to a higher speed. ACCEL is factory set for the shortest acceleration time (full CCW). To calibrate the ACCEL:

1. Set the speed adjust potentiometer for minimum speed.
2. Set the speed adjust potentiometer for maximum speed. Measure the time it takes the motor to go from minimum speed to maximum speed.
3. If the time measured in step 2 is not the desired acceleration time, turn the ACCEL trim pot CW for a longer acceleration time, or CCW for a shorter acceleration time. Repeat steps 1 through 3 until the acceleration time is correct.

Deceleration / DC Injection Braking (DEC/BK):

In Coast to Stop Mode (Dip Switch 2 = OFF), the DEC/BK setting determines the time the motor takes to ramp to a lower speed. DEC/BK is factory set for the shortest deceleration time (full CCW). To calibrate the DEC/BK:

1. Make sure Dip Switch 2 is OFF. See STARTUP section for dip switch location.
2. Set the speed adjust potentiometer for maximum speed.
3. Set the speed adjust potentiometer for minimum speed. Measure the time it takes the motor to go from maximum speed to minimum speed.
4. If the time measured in step 2 is not the desired deceleration time, turn the DEC/BK trim pot CW for a longer deceleration time, or CCW for a shorter deceleration time. Repeat steps 1 through 3 until the deceleration time is correct.

In DC Injection Braking Mode (Dip Switch 2 = ON), the DC Injection Braking setting determines the amount of current injected into the motor to quickly brake the motor. To calibrate the DEC/BK:

1. Make sure Dip Switch 2 is ON. See STARTUP section for dip switch location.
2. Set the DEC/BK trim pot full CCW.
3. Enable the drive.
4. Turn up the speed adjust potentiometer to full speed.
5. Disable the drive.
6. If the motor decelerates to zero speed too slowly, increase the DEC/BK trim pot and repeat steps 2 through 5 until the motor stops within the desired time.

Torque (TQ/LIM): The TQ/LIM setting determines the maximum torque for accelerating and driving the motor. If torque limit adjustment is desirable, but not critical, use the chart below for approximate TQ/LIM trim pot settings. Note that positions are relative to trim pot, not mounting position (ie 8:00 is full CCW on trim pot).

115 V	230 V	100%	150%	200%
1/2 HP	1 HP	11:30	2:00	4:00
1/3 HP	2/3 HP	10:30	11:30	2:00
1/4 HP	1/2 HP	9:30	10:30	11:30
1/8 HP	1/4 HP	8:30	9:00	9:30

If torque limit adjustment is critical, determine the motor's RMS current that correlates to desired torque limit and then:

1. With power disconnected from the drive, connect a RMS ammeter in series with one of the motor leads.
2. Turn the TQ/LIM trim pot to full CW. Apply power and adjust the motor speed to full rated speed.
3. Load the motor so that it draws the RMS current previously determined.
4. Slowly turn the TQ/LIM trim pot CCW until the red LED starts flickering. Then turn the trim pot slightly more so that it just starts to reduce the motor amps on the RMS ammeter.